

ALUPRO-N

Durable Lightweight Products

Scaling bars with accessories

PRODUCT OVERVIEW AND PRICELIST 2020



MADE IN NORWAY

Alupro-N delivers scaling bars that has been used by many of our Norwegian customers for several years. The scaling bars were developed in 2010 and are specially designed to be user-friendly and to have maximized product strength.

Application:

The scaling bars are used for prying rock and tunnel inspections and are particularly suitable in situations where low weight and high strength of the tool is an advantage. E.g. when working in height or where the equipment is to be transported manually to the work area.

In addition, the products are well suited to be used for demolition work in the construction industry.

Materials and forming technique:

The scaling bars are produced in a high strength aluminium alloy to secure a durable product with low weight for easy handling. To achieve as low weight and high strength as possible, we produce the products with our special forming technique where we can create hollow shaped bodies with solid end sections. The strength capacity of the alloy is therefore maintained at the same time as the weight is reduced. The scaling bars are completed by machining conical surfaces in both end sections where a variety of steel points can be mounted.

The replaceable steel points are produced in curable steel which has been adapted to fit the scaling bars.

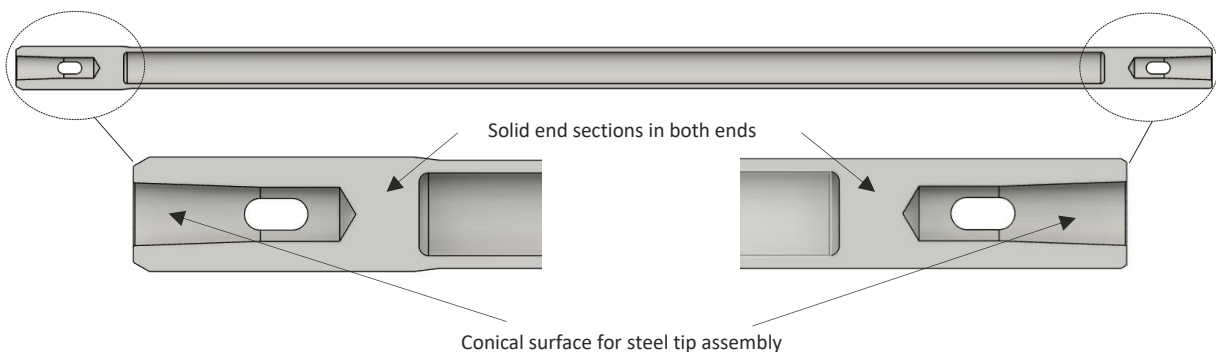





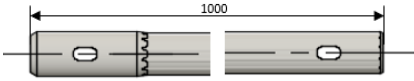
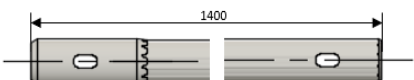

**Functionality:**

The conical shape in both ends of the aluminium body enables a swift and effective replacement of steel points or other equipment.

Customisations:

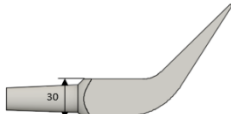
We have several standard accessories in stock, but we are more than willing to produce custom made equipment upon request.

Contact us either on e-mail or phone so that we can find the best solutions together.

Description	Article no.	Weight	Price* EUR	Illustration**
Scaling bar shaft 1,0m	642006	1,25 kg	85,-	
Scaling bar shaft 1,4m	642007	1.66 kg	85,-	
Scaling bar shaft w/eye 1,1m	642004	1,25 kg	85,-	
Pinched point 20x20 Curable steel	642011	336 g	25,-	
Steel point 20x20 Curable steel	642012	336 g	23,-	
NEW 2020! Steel point 30x30 Curable steel	642013	700 g	30,-	
NEW 2020! Pinched point 30x30 Curable steel	642014	700 g	32,-	
NEW 2020! Hammerhead 30x30 Curable steel	642015	235 g	27,-	
Joint piece Curable steel	642002	364 g	19,-	
Extractor	642005	150 g	8,5,-	
Rubber mounter	642009	50 g	4,5,-	

*All prices excl. VAT

**Not to scale

For questions and purchasing:

E-mail: firmapost@alupro-n.no

Phone: +47 72 89 30 30 / +47 924 56 109

Web: www.alupro-n.com

ALUPRO-N

Durable Lightweight Products